

Network Box Cameras

Quick Guide

Manual Version: V1.01

Thank you for purchasing our product. If there are any questions, or requests, please do not hesitate to contact the dealer.

Copyright

Copyright 2015 Zhejiang Uniview Technologies Co., Ltd. All rights reserved. No part of this manual may be copied, reproduced, translated, or distributed in any form or by any means without prior consent in writing from our company.

Trademark Acknowledgement

 and other Uniview's trademarks and logos are the property of Zhejiang Uniview Technologies Co., Ltd. Other trademarks, company names and product names contained in this manual are the property of their respective owners.

Disclaimer



The default password is used for your first login. To ensure account security, please change the password after your first login. You are recommended to set a strong password (no less than eight characters).

- To the maximum extent permitted by applicable law, the product described, with its hardware, software, firmware and documents, is provided on an "as is" basis.
- Best effort has been made to verify the integrity and correctness of the contents in this manual, but no statement, information, or recommendation in this manual shall constitute formal guarantee of any kind, expressed or implied. We shall not be held responsible for any technical or typographical errors in this manual. The contents of this manual are subject to change without prior notice. Update will be added to the new version of this manual.
- Use of this manual and product and the subsequent result shall be entirely on your own responsibility. In no event shall we be reliable to you for any special, consequential, incidental, or indirect damages, including, among others, damages for loss of business profits, business interruption, or loss of data or documentation, or product malfunction or

information leakage caused by cyber attack, hacking or virus in connection with the use of this product.

- Video and audio surveillance can be regulated by laws that vary from country to country. Check the law in your local region before using this product for surveillance purposes. We shall not be held responsible for any consequences resulting from illegal operations of the device.
- The illustrations in this manual are for reference only and may vary depending on the version or model. As a result, some of the examples and functions featured may differ from those displayed on your monitor.
- This manual is a guide for multiple product models and so it is not intended for any specific product.
- Due to uncertainties such as physical environment, discrepancy may exist between the actual values and reference values provided in this manual. The ultimate right to interpretation resides in our company.



Environmental Protection

This product has been designed to comply with the requirements on environmental protection. For the proper storage, use and disposal of this product, national laws and regulations must be observed.



Safety and Compliance Information

Safety Symbols

The symbols in the following table may be found on installation-related equipment. Be aware of the situations indicated and take necessary safety precautions during equipment installation and maintenance.

Symbol	Description
	Generic alarm symbol: To suggest a general safety concern.
	ESD protection symbol: To suggest electrostatic-sensitive equipment.
	Electric shock symbol: To suggest a danger of high voltage.

The symbols in the following table may be found in this manual. Carefully follow the instructions indicated by the symbols to avoid hazardous situations and use the product properly.

Symbol	Description
	WARNING! Indicates a hazardous situation which, if not avoided, could result in bodily injury or death.
	CAUTION! Indicates a situation which, if not avoided, could result in damage, data loss or

Symbol	Description
	malfunction to product.
	NOTE! Indicates useful or supplemental information about the use of product.

Safety Information

Installation and removal of the unit and its accessories must be carried out by qualified personnel. Please read all of the safety instructions below before installation and operation.

Installation

- This device is a class A product and may cause radio interference. Take measures if necessary.
- If the product does not work properly, please contact your dealer. Never attempt to disassemble the camera yourself. (We shall not assume any responsibility for problems caused by unauthorized repair or maintenance.)
- Make sure the power supply voltage is correct before using the camera.
- Do not drop the camera or subject it to physical shock.
- Do not touch sensor modules with fingers. If cleaning is necessary, use a clean cloth with a bit of ethanol and wipe it

gently. If the camera will not be used for an extended period of time, put on the lens cap to protect the sensor from dirt.

- Do not aim the camera lens at the strong light such as sun or incandescent lamp. The strong light can cause fatal damage to the camera.
- The sensor may be burned out by a laser beam, so when any laser equipment is being used, make sure that the surface of the sensor not be exposed to the laser beam.
- While shipping, the camera should be packed in its original packing.
- Do not stare at the optical interface (especially for the laser model) when the optical module is in operation.
- Keep the camera from water and other liquid to prevent fire and electric shock. Disconnect power before you move the camera. The camera is powered on when the power cord is connected to the power source.
- Brackets are required for wall mount and pendant mount. Keep away from vibration sources during mounting. You can install your camera with a housing to provide the correct level of protection. Choose a proper bracket and housing recommended by your dealer.
- In the circumstance of strong wind, we recommend you to use the professional standing pole (the bracket adapter is

not recommended) and big universal joint to ensure the stability of the camera.

- Do not connect the power adapter to the camera after it is connected to the mains supply. You are not allowed to remove the power cord from the camera before powering off the adapter.
- Use a proper power adapter or a PoE device. An improper power adapter may damage your camera.
- Ensure that the high level signal of alarm input is not higher than 5 VDC when connecting to the alarm input interface.
- Use the power cable connector delivered with the device. Make sure the connector is in good condition (clip) and secured into place. Do not fully stretch the power cord, otherwise, the connector may be loose or disconnected due to vibration or shake.
- Use the waterproof tapes to protect the end of tail cable, and keep the tail cable from water.
- The Ethernet optical interface and copper interface cannot work simultaneously. To switch to the copper interface, power off the camera first, remove the optical module, and then restart the camera after inserting the cable into the copper interface. To switch to the optical interface, power off the camera first, insert the optical module, and then restart the camera (you do not need to remove the cable

inserted to the Ethernet copper interface, because the optical port takes precedence in this case).

Maintenance

- If there is dust on the lens or the front glass surface, remove the dust gently using an oil-free brush or a rubber dust blowing ball.
- If there is grease on the lens, remove the grease using an oil-free cloth gently and then clean the lens in a circular spiral from the center outward using an oil-free cloth or a lens cleaning paper dipped with small amount of cleaning solution. If the grease still cannot be removed, change another oil-free cloth or lens cleaning paper and clean the lens gently until it is removed.
- If there is grease or a dust stain on the front glass surface, clean the glass surface gently from the center outward using anti-static gloves or an oil-free cloth. If the grease or the stain still cannot be removed, use anti-static gloves or an oil-free cloth dipped with detergent and clean the glass surface gently until it is removed.
- Do not use organic solvents, such as benzene or ethanol when cleaning the front glass surface.



- Never look at the transmit laser while the power is on. Never look directly at the fiber ports and the fiber cable ends when they are powered on.
- Use of controls or adjustments to the performance or procedures other than those specified herein may result in hazardous laser emissions.

Regulatory Compliance

FCC Part 15

This equipment has been tested and found to comply with the limits for digital device, pursuant to part 15 of the FCC Rules. These limits are designed to provide reasonable protection against harmful interference when the equipment is operated in a commercial environment. This equipment generates, uses, and can radiate radio frequency energy and, if not installed and used in accordance with the instruction manual, may cause harmful interference to radio communications. Operation of this equipment in a residential area is likely to cause harmful

interference in which case the user will be required to correct the interference at his own expense.

This product complies with Part 15 of the FCC Rules. Operation is subject to the following two conditions:

1. This device may not cause harmful interference.
2. This device must accept any interference received, including interference that may cause undesired operation.

LVD/EMC Directive



This product complies with the European Low Voltage Directive 2006/95/EC and EMC Directive 2004/108/EC.

WEEE Directive–2002/96/EC



The product this manual refers to is covered by the Waste Electrical & Electronic Equipment (WEEE) Directive and must be disposed of in a responsible manner.

Contents

1 Appearance Description.....	1
Dimensions and Appearance	1
4 Pin Z/F Interface.....	2
Rear View.....	3
Cable Connection.....	6
Status Indicator.....	7
2 Mount Your Camera	8
Mount the SFP Module (Optional).....	8
Mount the Wi-Fi Antenna	9
Insert the SD/Micro SD Card (Optional).....	11
Wall Mount (Without Housing).....	12
Install the Camera in a Housing	16
Reset the Camera to Default Settings.....	19

3 Set Your Camera over the LAN	19
4 Access Your Camera	20
System Requirements for Your PC	21
Access Your Camera	22
Install the ActiveX	23

1 Appearance Description

The appearance and interfaces may vary with your camera model. The figures in the manual are for your reference only. For the actual appearance and interfaces, see the product.

Dimensions and Appearance

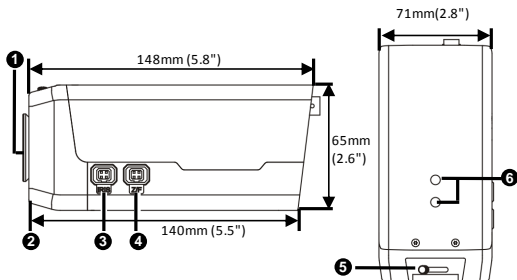

-
- 1: Dustproof cover for lens interface
 - 2: Lens mounting interface (CS mount)
 - 3: DC-Iris control interface
 - 4: Zoom/focus control interface
(Connect to lens via 4 Pin Z/F connector)
 - 5: Back focus puller
-

6: Mounting interface (for connecting a bracket)

4 Pin Z/F Interface

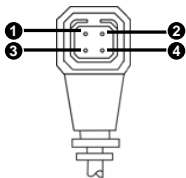

No.	Description	No.	Description
1	FOCUS+	2	FOCUS-
3	ZOOM-	4	ZOOM+



For the latest specifications, see the product datasheet.

Rear View

Type A

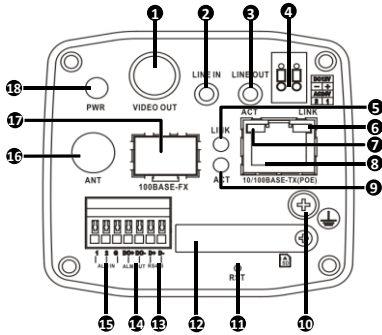

Type B

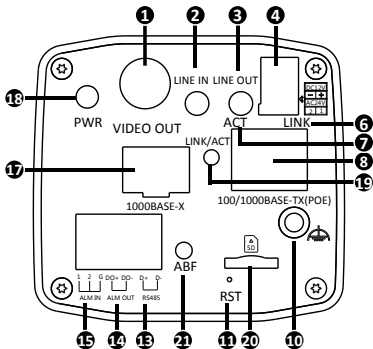

1: BNC Output for locally outputting compound video signals

2: Audio input interface

Note:

Please use audio connectors with dual channels.

3: Audio output interface

Note:

Please use audio connectors of dual audio channels.

4: Power connector, 12 VDC or 24 VAC

5: Ethernet optical interface network connection indicator

6: Ethernet copper interface network connection indicator

7: Ethernet copper interface data transmission indicator

8: Ethernet copper interface, with some models supporting PoE (conforming to IEEE802.3af)

9: Ethernet optical interface data transmission indicator

10: Grounding terminal

11: RST button

Note:

Press and hold the RST button for about 15 seconds to restore factory default settings. The RST button only works within ten minutes after the device is powered on. Some model may not support this function, please refer to the actual internal structure.

12: SD card slot (with a dustproof cover)

13: RS485 serial port

14: Alarm output

15: Alarm input

16: Antenna interface for connecting the Wi-Fi antenna to receive wireless signals

17: SFP optical module slot (with a dustproof cover)

18: System status indicator

19: Optical status indicator

Note:

Steady on: Connection established.

Blinking: Data transmitted.

20: Micro SD card slot (dustproof cover not included)

21: ABF button (for adjusting the back focus)

Note:

Fine-tune the back focus to get a clear image.

Cable Connection

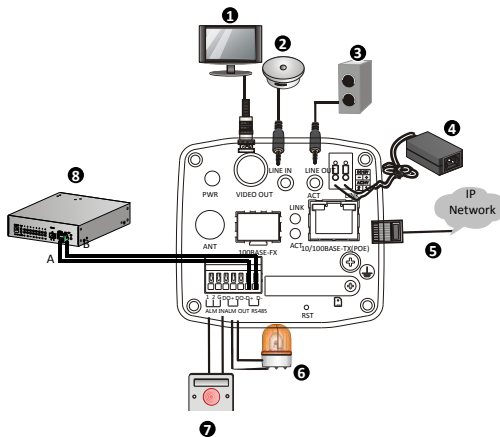

1: Display device	2: Audio input(sound pickup)
3: Audio output(sound box)	4: Power adapter
5: Network	6: Alarm output(alarm indicator)
7: Alarm input device(voice activated switch)	
8: RS485 connection(vehicle detector)	

Status Indicator



For Ethernet optical interface on Type B cameras, the LINK/ACT indicator on the panel works as the network connection indicator and data transmission indicator at the same time.

Indicator	Abbreviation	Color & Description
System status indicator	PWR	Yellow: The camera is starting up Green: The camera is operating Red: Alarm is preset
Network connection indicator	LINK	Green on: The camera is connected to network Green off: The camera has no connection to network
Data transmission indicator	ACT	Blinking yellow: Data is transmitted Yellow off: No data transmission

2 Mount Your Camera

The following takes [Type A](#) series cameras as an example.

Mount the SFP Module (Optional)



- The SFP optical module is supported by some models and needs to be purchased separately.
- Select a proper optical module according to the environment temperature. For outdoor mounting, the upper temperature limit of the optical module must be higher than 85°C.
- Do not bend the fiber at sharp angle.

To mount an SFP optical module (taking a two-fiber bidirectional module as an example), perform the following steps:

1. Remove the slot dustproof cover.

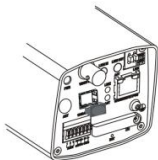

2. Insert the SFP optical module recommended by your dealer.



3. Connect the optical fiber plug and the optical module.

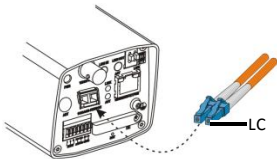

Mount the Wi-Fi Antenna

Only certain models support Wi-Fi.

1. Mount the Wi-Fi antenna, and check that the antenna is in position. Aim the thread end of the Wi-Fi antenna at the bolt of the antenna port.

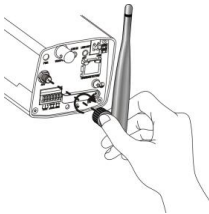

2. Adjust the direction of the Wi-Fi antenna as required.

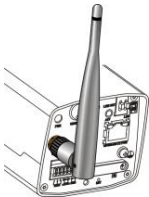

Insert the SD/Micro SD Card (Optional)



- For details about recommended SD/Micro SD card specifications, contact your dealer.
- For Type B cameras, Micro SD slots do not have dustproof covers, so skip the steps for opening/closing dustproof cover.
- Do not hot plug the SD/Micro SD card after it is inserted. Otherwise the camera or the SD/SD card might be damaged.

1. Loosen the screws on the dustproof cover, and remove the dustproof cover.

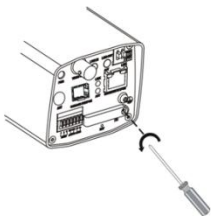

2. Insert the SD/Micro SD card as instructed.

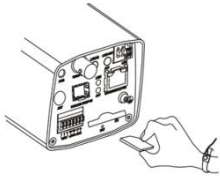

3. Reinstall the dustproof cover.

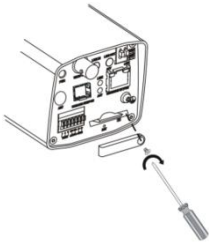

Wall Mount (Without Housing)

Wall mount is applicable to indoor installation, and requires you to purchase a bracket and prepare other necessary accessories (such as electric drill and hammer). Pendant mount is similar to wall mount and therefore is not described separately.

- 1.** Locate the positions of the holes.
 - a.** Locate the positions of the holes on the wall by referring to the bracket mount points.
 - b.** Lead the cables across the hole on the wall.

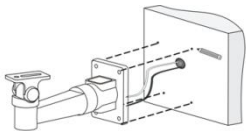

- 2.** Drill holes on the wall.

Select a drill bit matching the outer diameter of the expansion bolts. Refer to the length of the bolts for the hole depth.

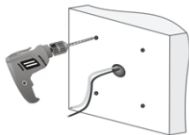

3. Mount the expansions bolts.

Knock in the expansions bolts, making sure that they are firm.

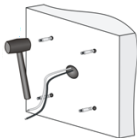

4. Mount the bracket onto the wall.

a. Lead cables out of the leading-out hole of the bracket.

b. Fix the bracket to the expansion bolts, and lock the bracket by using flat washers, spring washers, and nuts.

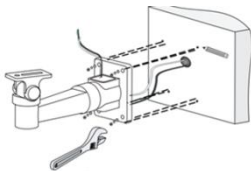

5. Mount the lens and then mount the camera onto the bracket.



6. Perform accurate adjusting after power-on.



- If you use a C-mount interface lens, you need a C/CS adapter ring to mount the C-mount lens to the camera body.
- If you use a motorized zoom lens, you can remotely control zoom and focus after connecting the zoom/focus control cable to the Z/F interface (using a 4-pin Z/F connector) of the camera. To automatically adjust the aperture, connect the aperture control cable to the IRIS interface of the camera.

Install the Camera in a Housing

A housing is required for outdoor installation, and you need to purchase a bracket and prepare necessary accessories (such as screwdrivers). The following takes pole mount as an example. Other mount modes are similar and are not be described separately in this guide.

1. Select a proper housing, and remove the bottom plate.

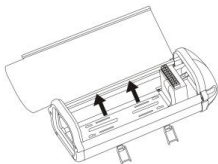

2. Fix the camera onto the bottom plate.

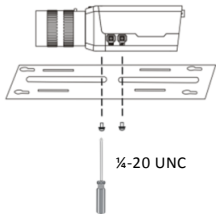

- 3.** Fix the bottom plate and the housing.

Tighten four self-tapping screws through hardy holes.

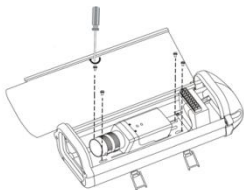

- 4.** Fix the universal joint onto the back panel of the housing.

Loosen the two screws on the universal joint to fix it to the housing.

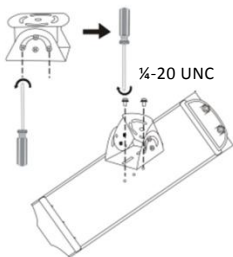

5. Fasten the clamps and secure the steel straps to the cross arm.

Lead cables through the pole and out of the cross arm, waiting to be connected.

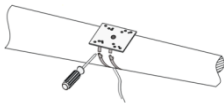

6. Fix the housing on the steel straps.
 - a. Adjust the universal joint and the housing until the monitoring direction is proper.
 - b. Lead the power cord and the network cable through the cabling hole of the housing, and connect the camera.

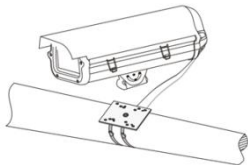

7. After the camera is powered on, adjust the display of your camera. For the detailed steps, see [Access Your Camera](#).

Reset the Camera to Default Settings

Use a toothpick or clip to press and hold the RST button (as shown in the figures in [Rear View](#)) at the bottom for about 15 seconds till the PWR LED turns red. The RST button only works within ten minutes after the camera is powered on. The camera is restored to the default settings after the startup.

3 Set Your Camera over the LAN

To view and configure your camera via the LAN (Local Area Network), you need to install the EZStation to find your camera and change its IP address.



- Please contact your dealer to obtain the EZStation.
- Please refer to the user manual of EZStation for detailed information.

1. Connect your camera and your PC as shown in the figure below to ensure the routing is available.



2. Use EZStation to search online cameras automatically.
3. Modify the camera settings if necessary, including its IP address and subnet mask.



- The default IP address is “192.168.0.13”. The default username is “admin”, and the default password is “123456”.
- To access your camera from a different subnet, set the gateway for your camera after you log in.

4 Access Your Camera

You can directly control and manage your camera through the Web on a PC.

System Requirements for Your PC

Item	Requirements
Operating system	Microsoft Windows 8/Windows 7/Windows XP (32-bit or 64-bit). Microsoft Windows 7 (32-bit) is recommended.
CPU	2.0 GHz or higher, dual-core. Intel i3 CPU or higher is recommended.
Memory	At least 1 GB. 2 GB (or higher) is recommended.
Graphic card	At least 128 MB display memory. Mainstream discrete graphics with more than 1 GB display memory are recommended. The hardware should support DirectX9.0c. Note: Make sure that the latest driver is installed on graphic card.
Sound card	Required. Note: Two-way audio and voice broadcast require the latest driver on sound card.
Network card	Megabit Ethernet network cards (or higher) are recommended.

Access Your Camera

Before you begin, check that:

- Your camera is operating properly and connected to the network.
- The PC you are using is installed with Internet Explorer 7.0 or later. IE 8.0 is recommended.

Follow these steps to access your camera through the Web:

1. Open your browser, input the IP address of your camera (default IP is 192.168.0.13) in the address bar and then press **Enter** to open the login page.
2. Enter the username (default is “admin”) and password (default is “123456”) and then click **Login**.
3. Install the ActiveX at your first login. For the detailed steps, see [Install the ActiveX](#). When the installation of the ActiveX is completed, open your IE to log in.
4. Enter the live view page, and then adjust the zoom and focus of lens to get a clear image.



- You can connect the local video output interface on your camera to your monitor. When video is displayed on your monitor, adjust the zoom and focus of your camera while watching the display till you get a satisfying display.
- For manual lens, adjust zoom and focus by turning the lens. For motorized zoom lens, click the **Zoom** and **Focus** buttons on the Web page.
- To adjust the viewing direction of your camera, loosen the knob on the bracket and then adjust the direction as required. Tighten the knob after you finish the adjustment.
- For cameras that do not support ABF function, adjust the back-focus manually to get a clear image.

Install the ActiveX

The following takes the IE browser as an example to describe the installation steps.

1. Click **Download**.



Failed to load ActiveX control, click [Download](#) to install latest ActiveX control.

2. Click **Run**. You may also click **Save** to download the file to your computer first.
3. Close the browser and follow the steps to complete the installation.



- For your first login with Windows 7, if the system does not prompt you to install ActiveX, follow these steps to turn off UAC: click the **Start** button, and then click **Control Panel**. In the search box, type **uac**, and then click **Change User Account Control Settings**. Move the slider to the **Never Notify** position, and then click **OK**. After UAC is turned off, log in again.
- If the installation failed, open **Internet Option** in IE before login. Click the **Security** tab, click **Trusted sites**, and then click **Sites** to add the website. If you use Windows 7, you need to save the setup.exe to your PC first, and then right-click the file, select **Run as administrator**, and then install it according to instructions.

BOM: 3101C0BW